



TCS 80X

User Manual

V3.0 JMK 31 October 1996

 This equipment has been tested and found to comply with the following European Standards for Electromagnetic Compatibility:

Emission Specification:	EN55013	(1990)	(Associated equipment)
Immunity Specification:	EN50082/1	(1992)	(RF Immunity, Fast Transients and ESD)
Mains Disturbance:	EN61000/3/2	(1995)	

For continued compliance ensure that all input and output cables are wired with cable screen connected to Pin 1 of the XLR. The input XLR Pin 1 on BSS equipment is generally connected to chassis via a capacitor to prevent ground loops whilst ensuring good EMC compatibility.

We have written this manual with the aim of helping installers, sound engineers and consultants alike get to grips with the **TCS-80X** series and obtain its maximum capability.

If you are new to BSS equipment, we recommend that you begin at the start of the manual. If, however, you are already familiar with the intended application, and just want to get the unit installed without delay, then follow the highlighted sections.

Since this manual is dual purpose in covering both the **TCS-803** and the **TCS-804** units, information that applies to only one of the units will be clearly noted for you. Where a particular function applies to both units, the method of access and operation is identical for both units and the manual will show pictures of the **TCS-804** as an example.

Should you have any comments or questions about applying the **TCS-80X** series within your application, please write to us, or e-mail us, at the addresses in the warranty section.

We welcome any comments or questions regarding the **TCS-80X** series or other BSS products, and you may contact us at the address or World Wide Web site given in the warranty section.

Contents

1.0	The TCS-80X Series.	5
2.0	What is special about BSS Delays?	6
3.0	Earthing Requirements	7
4.0	Unpacking	7
5.0	Mechanical Installation	12
6.0	Mains Power Connection	13
7.0	Input Connections	14
7.1	XLR Plugs.	14
8.0	Output Connections	15
8.1	XLR Plugs	15
9.0	Control Connections	15
10.0	Powering Up	16
10.1	Default Settings and Display	16
10.2	Error Message Display	17
10.3	Mode Setting (TCS-804 only)	17
11.0	Parameter Selection	18
11.1	Bypass	19
11.2	Adjust Delay Time or Distance	19
11.3	Adjust Input and Output Level TCS-803	19
11.4	Adjust Input and Output Level TCS-804	20
11.5	Output Mutes	21
11.6	Program Store and Recall	22
11.7	Control Lockout	23
11.8	Utility	24
12.0	Master/Slave Operation	26
13.0	Linking (TCS-804 Only)	27
13.1	Stereo Pairs	27
13.2	Relative Delay, Mono mode	28
13.3	Relative Delay, Dual Chan Mode	29
14.0	Applications	31
14.1	Time Correction for Audience Distances	31
14.2	Time Correction for Speaker Driver Placement	31

Contents

15.0	Midi Implementation	34
16.0	Chassis/0v Link Removal	36
17.0	BSS Temperature Probe	36
19.0	Extended Memory	37
19.0	Transient Suppressor Replacement	37
20.0	Option Transformers	38
21.0	Specifications	39
22.0	Warranty Information	41

	Index	42
	User Notes	43

Spare Parts Information

1.0 The TCS-80X Series.

The **TCS-803** and **TCS-804** form a series of multitap time correction units that offer you the very best from today's affordable digital technology. Utilising advanced BSS proprietary conversion techniques they have exceptional headroom, phase linearity and low level resolution that will not weaken a conventional high quality analogue signal processing chain. Whether your application is professional live sound, theatre sound, broadcast or disc mastering the **TCS-80X** series will offer the most cost effective and intelligent high specification multitap time delay that is available.

BSS Delays

2.0 What is special about BSS Delays?

Some of the features available within the series are:

- Stereo operation with two outputs per channel accurately linked, or dual mono one-in/two-out.
- Mono one-in/four-out on the **TCS-804**. Mono one-in/three-out on the **TCS-803**.
- Friendly rotary control knob for all parameter adjustments.
- Time or distance entry and display in milliseconds, feet, inches or metres.
- 10uS minimum delay steps.
- 105dB usable dynamic range includes full +20dBu headroom with fine resolution at low signal levels. No companding or pre-emphasis means superior high frequency performance.
- Exceptional phase linearity and HF accuracy from high sample rate and gentle filtering.
- 12 non-volatile user programmable memories with remote recall via contact closure or Midi.
- Maximum delay up to 2.6 seconds on TCS-804 in mono mode up to 1.3 seconds on TCS-803.
- Master/slave linking of multiple units by Midi.
- Delay time compensation for auditorium ambient temperature change. Fully automatic on the TCS-804 with optional probe fitted.
- Electronic security lockout with optional mechanical security cover.
- Relay controlled signal bypass optionally available which is also linked into fail-safe processor and power supply watchdog.
- Digital level control for both input headroom and output gain on the **TCS-804**, gives automatic headroom compensation and allows remote control of output levels and program storage.

Every **TCS-80X** is manufactured to the highest professional standards with a robust steel case, high quality circuit boards and ICs, and high quality components to provide reliable performance under the most demanding conditions of the global sound-reinforcement environment. In common with all other BSS equipment, the **TCS-80X** is subject to stringent quality control procedures throughout the manufacturing process. Components are tested against demanding acceptance criteria. Every completed unit is tested both by measurement and in a listening test carried out by trained audio professionals. To positively ensure reliability, all units are burnt-in for fifty hours, before being tested.

Earthing Requirements Unpacking

3.0 Earthing Requirements

WARNING! THIS APPLIANCE MUST BE EARTHED.

IMPORTANT: The wires in the mains lead are colour coded in accordance with the following code.

Green and Yellow.....Earth

Blue.....Neutral

Brown.....Live

As the colours of the wires in the mains lead may not correspond with the markings identifying the terminals in your plug, proceed as follows.

- ① The wire which is coloured Green and Yellow or Green must be connected to the terminal which is marked with the letter 'E' or by the Earth signal  or which is coloured Green and Yellow or Green.
- ② The wire which is coloured Blue must be connected to the terminal labelled 'N' or coloured Black or Blue.
- ③ The wire which is coloured Brown must be connected to the terminal labelled 'L' or coloured Red or Brown.

Those units supplied to the North American market will have an integral moulded 3 pin connector which is provided to satisfy required local standards.

The mains voltage selector switch provides a simple external adjustment to allow operation on all international AC power standards. The allowable ranges for the supply voltage are:

90VAC up to 132VAC on the 120V position and

180VAC up to 264VAC on the 240V position.

Outside of these ranges the unit will not work satisfactorily, if at all. Voltages in excess of the maximum will probably cause damage. Voltages below the minimum will cause the power supplies to drop out of regulation, degrading the performance of the system.

4.0 Unpacking

As part of BSS' system of quality control, this product is carefully inspected before packing to ensure flawless appearance.

After unpacking the unit, please inspect for any physical damage and retain the shipping carton and ALL relevant packing materials for use should the unit need returning.

In the event that damage has occurred, please notify your dealer *immediately*, so that a written claim to cover the damages can be initiated. *See Section 22.*

Getting to know the TCS-803

Fig 4.1 TCS-803 Front Panel

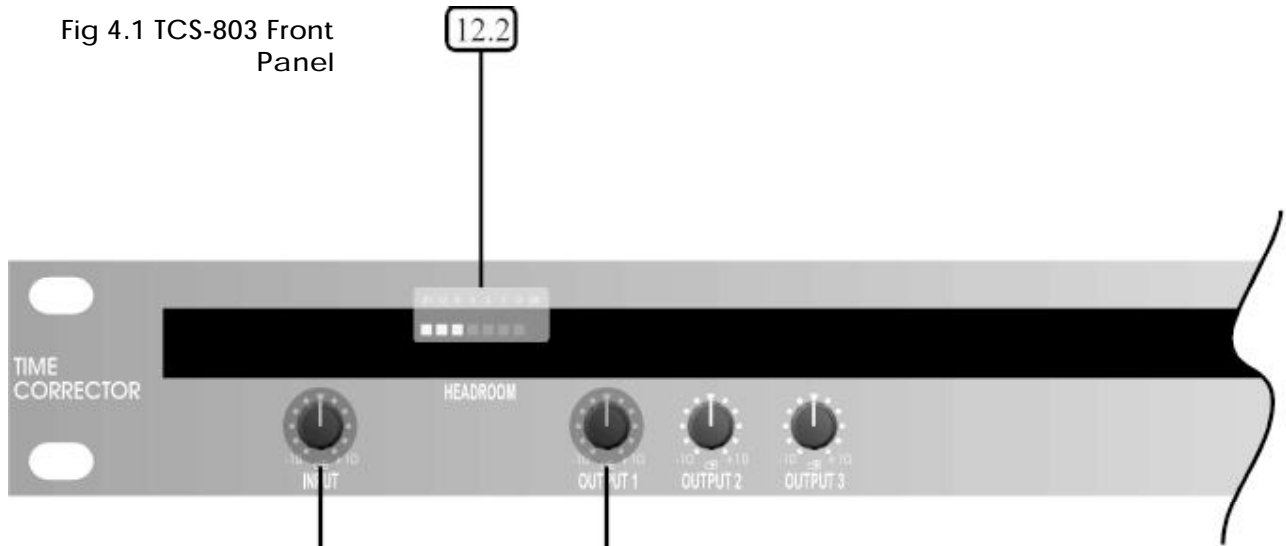
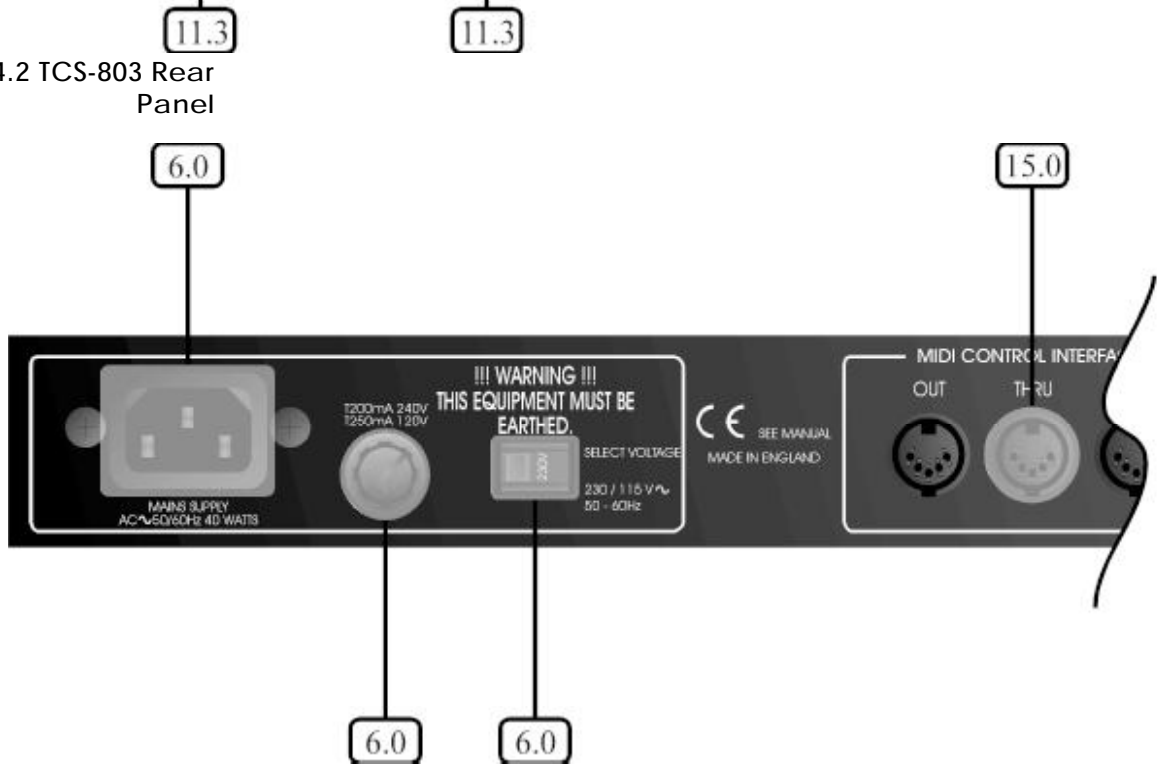
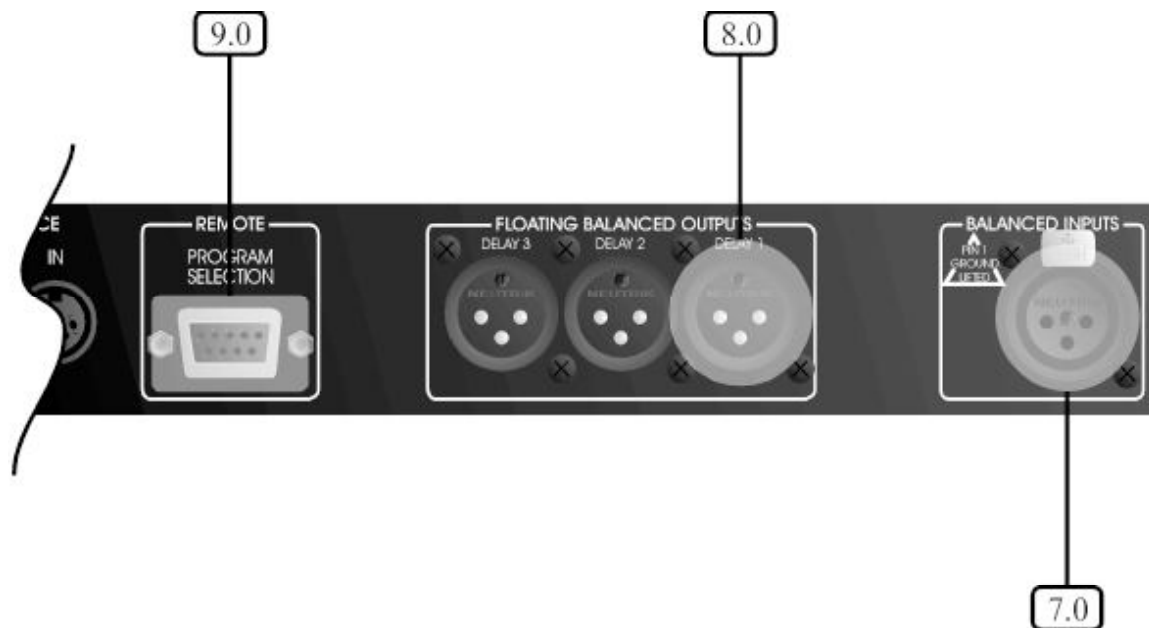
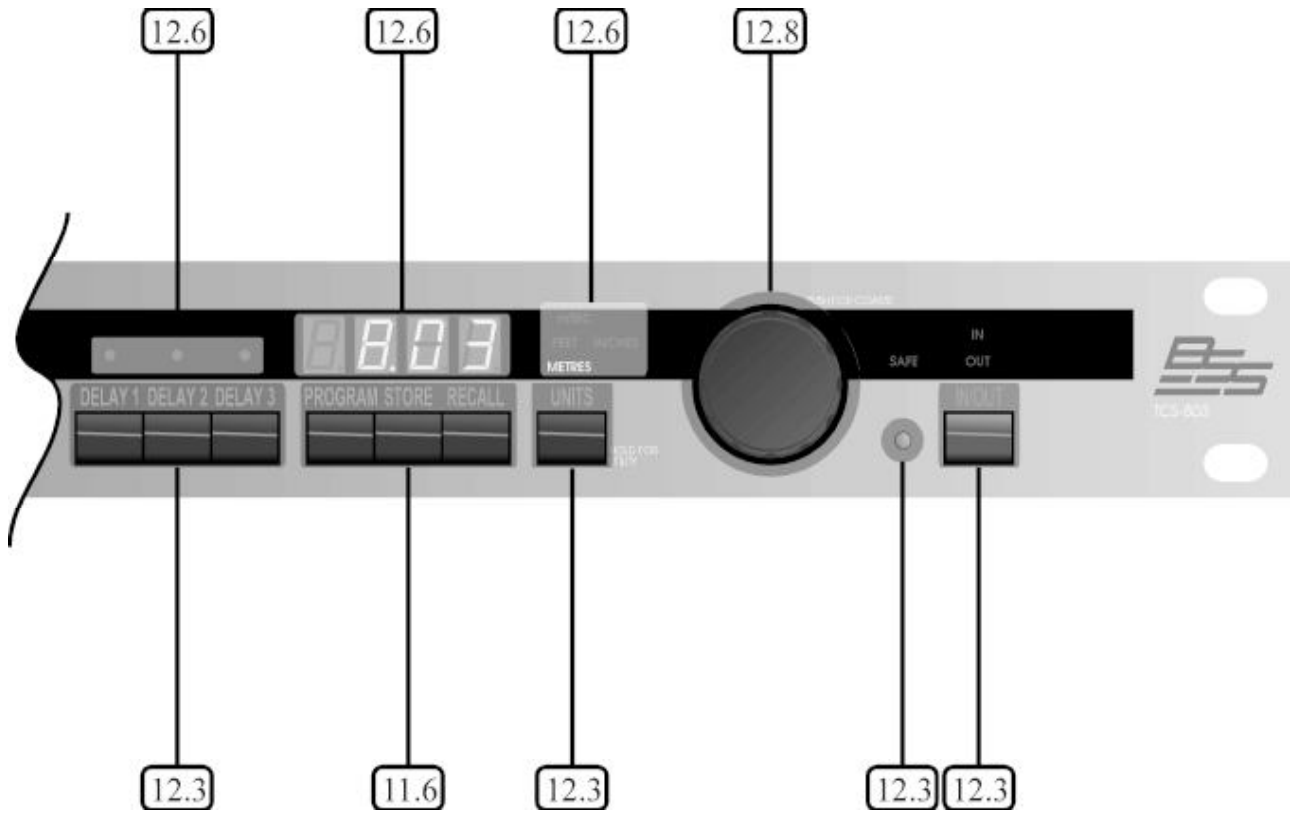

Fig 4.2 TCS-803 Rear Panel





All numbers in bubbles refer to Section numbers.

Getting to know the TCS-804

Fig 4.3 TCS-804 Front Panel

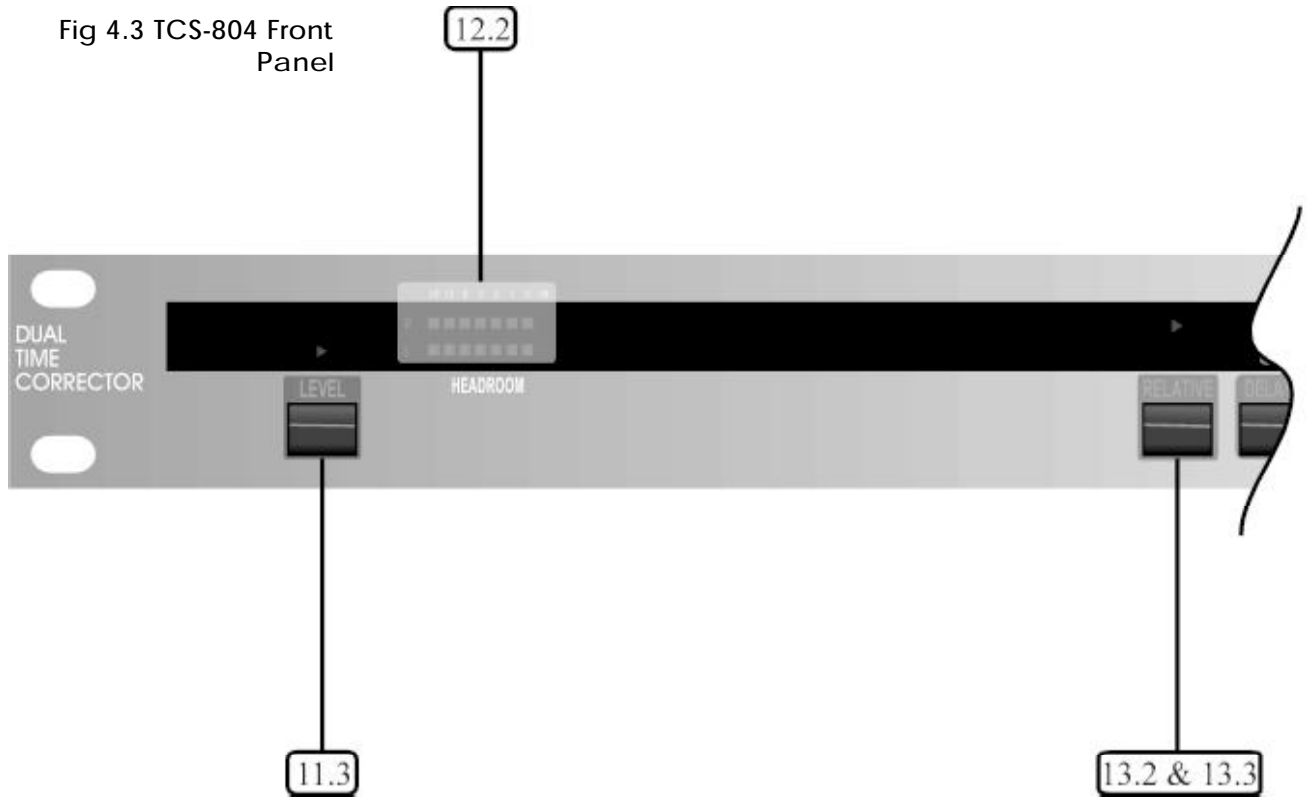
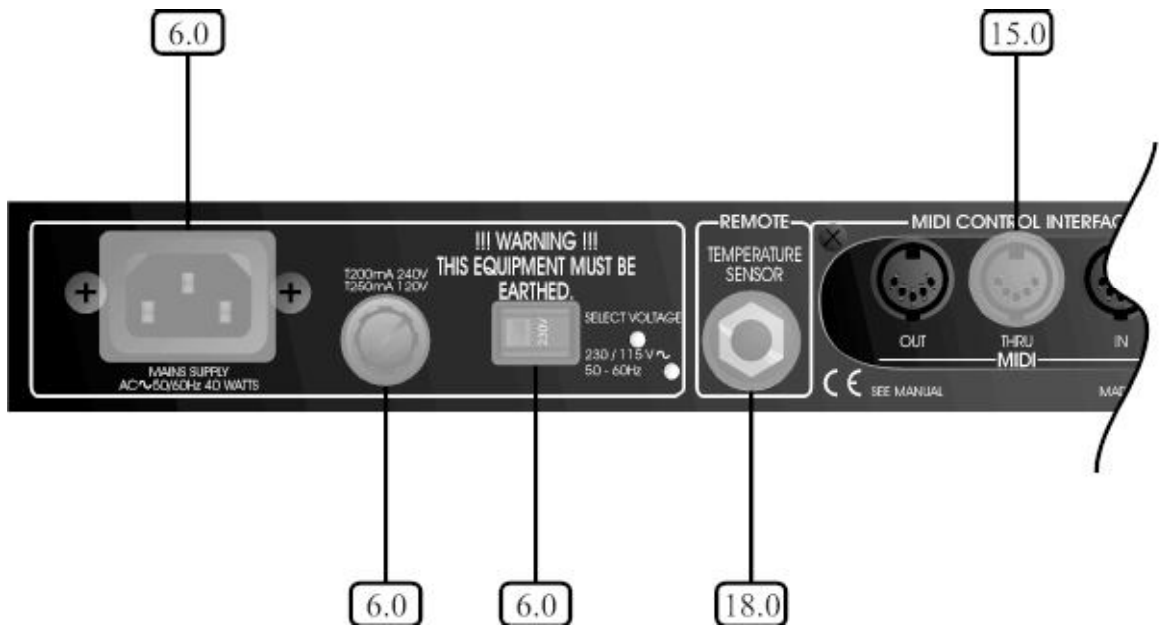
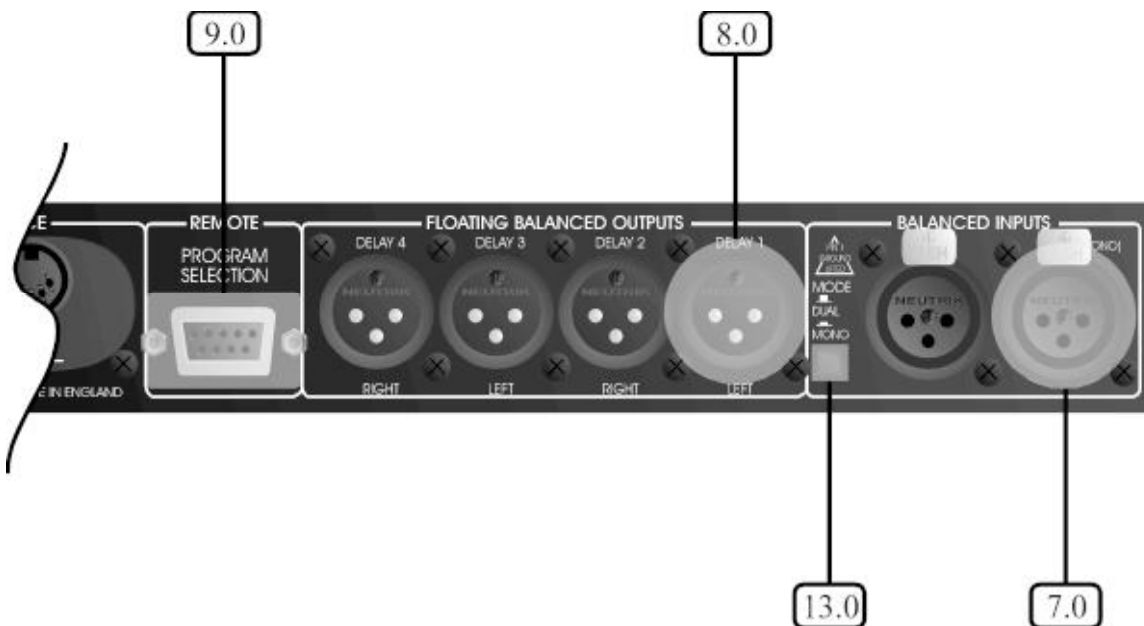
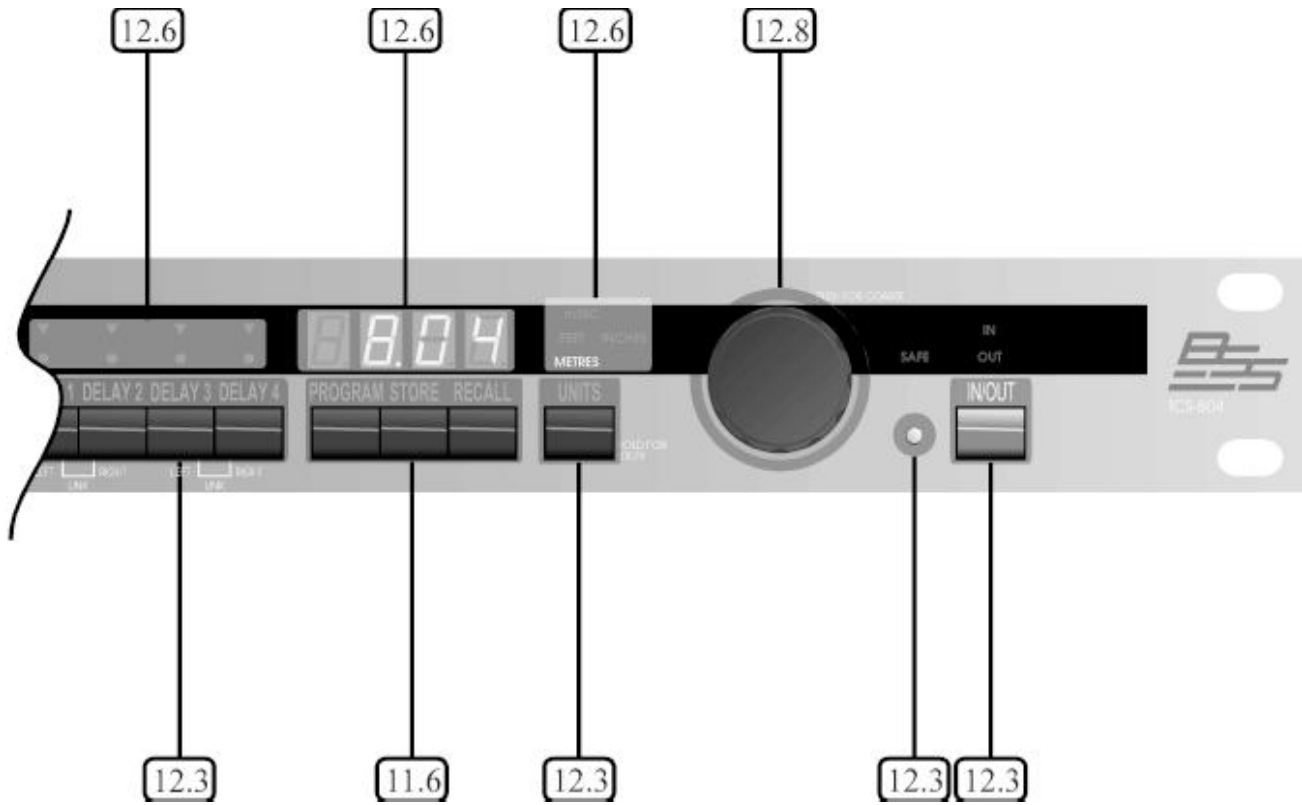

Fig 4.4 TCS-804 Rear Panel





All numbers in bubbles refer to Section numbers.

Installation

5.0 Mechanical Installation

A vertical rack space of 1U (1¾" / 10½mm) deep is required. Adequate ventilation must be provided for by allowing sufficient room around the sides and rear of the unit for the circulation of air (*See Figure 5.1*).

If the TCS-80X are likely to undergo extreme vibration through extensive road trucking and touring, it is advisable to support the unit(s) at the rear and/or sides to lessen the stress on the front mounting flange. Failure to do so may impair reliability and will invalidate the warranty. The necessary support can generally be bought ready-built, as a rack tray. As with any low-level signal processing electronics, it is best to avoid mounting the unit(s) next to a strong source of magnetic radiation, (for example, a high power amplifier), to help keep residual noise levels in the system to a minimum. The front of the unit should not be exposed to long term sunlight, as this can have a detrimental effect on the display lens.

The internal power supply regulators are mounted on the case sides and use this as their heatsink. After a period of time in an enclosure, the metal case will feel hot to the touch, but this is quite normal and should not be a cause for alarm.

Fig 5.1 Unit dimensions.

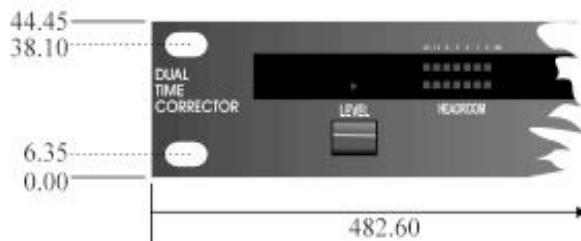

Note: All dimensions in mm.

Fig 5.2 Rack dimensions.

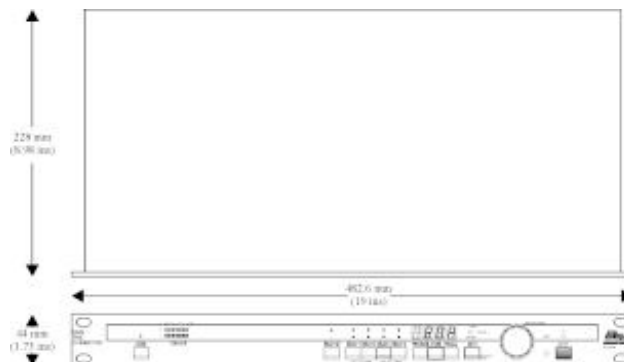

Connecting to Power

6.0 Mains Power Connection

Voltage: The TCS-80X operate on voltages specifies in the earthing requirements section (Refer to section 3). If the unit(s) are accidentally connected to an AC supply giving in excess of 132V AC, refer to section 19, (See Figure 6.1).

Frequency: Both 60Hz and 50Hz are acceptable.

Fig 6.1 Mains fuse on rear panel.



Grounding: The TCS-80X must always be connected to a 3-wire grounded ('earthed') AC outlet. The rack framework is assumed to be connected to the same grounding circuit. The unit(s) must NOT be operated unless the power cables' ground ('earth') wire is properly terminated - it is important for personal safety, as well as for proper control over the system grounding.

Connections: The AC power cable has a moulded 3-pin utility plug attached to the free end to facilitate the correct and proper connections.

AC Power Fusing: The incoming line power passes through a 150mA (for 240V only) anti-surge ('T') fuse, accessible from the rear panel (The fuse is rated at 250mA for 120V and 150mA for 240V). If the fuse blows without good reason, refer to section 19. Always replace with an identical 20mm x 5mm T rated fuse for continued protection from equipment damage and fire.

It is unlikely that a fuse will fail during normal use, and must be treated with some caution to the cause, if it should do so. One of the most likely reasons for failure is the incorrect setting of the voltage switch on the rear of the unit. Another reason could be the inadvertent connection of line to line rather than line to neutral phase voltages when using three phase power supplies. In either case, internal transient suppressor can be damaged, and consequently replacement fuses will continue to blow, providing protection for your unit. The damaged suppressors must be removed from the unit to allow further use, and should be replaced as quickly as possible to provide continued protection. Refer to section 16 for information on replacing these suppressors.

Input Connections

7.0 Input Connections

7.1 XLR Plugs. The input signals are 10k ohm active balanced on a standard 3 pin 'female' XLR which will accept levels up to +20dBv, and can drive into loads of 600ohms or greater. The wiring convention is as follows: (*See Figure 7.1*):

Pin 1: No connection (the shield of the drain wire can be terminated here if desired).

Pin 2: Signal '+', in phase or 'HOT'.

Pin 3: Signal '-', out of phase or 'COLD'.

For unbalanced sources (*See figure 7.1*):

Pin 1: Leave open, or link to pin 2.

Pin 2: Shield, braid, or screen wire.

Pin 3: Signal '+' or 'HOT' (inner core).

There is no internal ground connection to Pin 1 of the female XLR to avoid possible interconnection earth loops. The input signal cable shield *must* therefore be tied to ground, or signal 0V, at the source end.

Fig 7.1 XLR Plug Wiring



If the equipment driving the TCS-80X has only unbalanced outputs then you will need to add a wire jumper such that the screen connection on Pin 1 of the XLR is shorted to either Pin 2 or Pin 3, depending on system convention.

If the equipment being connected to the TCS-80X outputs have only unbalanced inputs, then we recommend that you still use a balanced (i.e. 2 core shielded) cable. You should ground the shield from the pin 1 connection, whilst the cold connection should be used as the 0v ground and the hot connection for the live, on the unbalanced input. The cable screen should not be connected through to the chassis/0V. Strict adherence to this will help to eliminate potential ground loop hums.

Strict adherence to the wiring conventions noted above within a fully balanced signal system will yield the best possible results with none of the problems normally associated with interconnected audio equipment. Wherever possible, cable screens should not be connected to any signal pin, but rather left to perform a cable shielding function only.

Under no circumstances should the safety ground wire be removed from the mains AC power connector as an interim measure to achieve similar results. Please refer to section 16 for information on this procedure.

Output Connections
Control Connections

8.0 Output Connections

8.1 XLR Plugs The four signal outputs are DC blocked low impedance unbalanced from a standard 3 pin male XLR and are designed to drive up to +20dBv into 600 ohms or greater. The wiring convention is as follows:

- Pin 1: Connects to shield, screen or drain wire.
- Pin 2: '+', hot or 'in phase' output.
- Pin 3: '-', cold or 'out of phase' output.

If the amplifiers you are feeding have unbalanced (single ended) inputs, but are fed from standard pin to pin XLR cables (See above), simply link the cable at the crossover end as follows:

- Pin 1: Connects to shield or screen wire.
- Pin 2: Link to Pin 1.
- Pin 3: Connects to the inner 'hot' or live core.

Unbalanced transmission is not recommended for connections to distant equipment, but is generally acceptable for local connections within the rack, or to an adjacent rack.

Technicians note: As with a traditional transformer balanced output, either output phase (+ or -, hot or cold) can be linked to ground to 'unbalance the line' without upsetting the operation of the unit. BSS follows the convention of 'screen goes forward with the signal'. As with a transformer, output level remains the same in the unbalanced mode.

9.0 Control Connections

Both the **TCS-803** and **TCS-804** have two external control ports, one being the Remote Program Selection, the other a standard MIDI control interface having both IN, THRU and OUT connectors. More about the MIDI option and its control codes are detailed in **section 15**. The 9 pin Remote Program Selection 'D' type connector is wired as a 4 by 3 matrix which allows by simple switch closure, the selection of 12 user programmable memories. **Figure 9.1** gives the matrix pinning for each program number.

Remote Program Selection The voltage available at these pins is less than 5V and current limited, so that no particular attention needs to be paid to safety and either momentary or latching switch closure is all that is required to recall a memory number. Individual screened cable is not required to connect your remote switching box to the **TCS-80X**, however it is recommended that you use a cable that has an overall screen, which should be connected to your control box at one end and the designated pin on the D-Connector at the other end.

PX is the program number which is recalled by connecting together the two designated pin numbers. Pins 5 and 9 are connected to ground

Fig 9.1 Remote Program Selection D-Connector Wiring

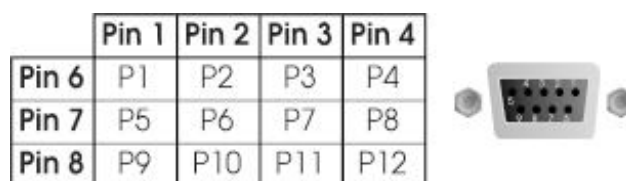

Powering Up

10.0 Powering Up

When the TCS-80X is switched on, by operating the power on-off switch located on the rear panel, the internal circuitry carries out a series of routine diagnostic tests. The display will show a series of numbers which will advise:



- The TCS model number, plus a suffix 'E' if the internal memory has been extended.



- The software version number currently fitted.



- Which interface option is fitted (TCS-804 only).



- If the BSS temperature probe is fitted (TCS-804 only)

10.1 Default Settings and Display

Following the startup routine and screen display, the TCS-80X will automatically resume the settings that were last selected, and show the last selected delay before the previous switch-off. When first powered up, the factory set defaults will be as shown below.

The internal memory automatically remembers all switch functions and display readings when the unit is switched off, so it is not necessary to reload level and delay information every time the unit is activated. The same applies for the user programs, whose memory retains their contents indefinitely when mains power is removed.

Factory Default Settings:

TEMP	20°C
HEADROOM	+10dBu
GAIN	0dB
DELAY	0mS
MIDI CHN	CH.1
Tx. MODE	Tr. Pr
PGM MEMORY	P 1
MODE	MONO
LINKING	None

10.2 Error Message Display

Should the unit detect bad data internally, on a control interface, or an incompatible mode setting, an error message number will be displayed to show there is a problem. Any other indicated errors will require the unit to be referred to an authorised service centre for repair.



Err.3 Midi timing error

Err.4 Option interface timing error

Err.5 Incorrect mode selected for master-slave linking or program recall

Err.6 Program Store Error

10.3 Mode Setting (TCS-804 only)

The two modes of operation of the unit are selected by the push switch located on the rear panel and labelled 'mode select'.

Confirmation of the selected mode will be seen from the front panel display. For MONO mode the top headroom meter display will be active, as will the legend MONO. In DUAL CHANNEL mode the MONO legend will be extinguished and replaced by the letters L and R adjacent to each headroom display meter.

The MONO operation mode is where all four delay outputs are part of the one channel, this being the 'left' channel. Four independent delay taps from the one unit give extra flexibility in system design. Please use the legend printed above the delay selection switches.

In DUAL CHANNEL mode, the **TCS-804** is partitioned, to give two identical channels, each one having two delay outputs. Each channel can be operated separately, or with the output pairs linked as is necessary for true stereo operation. Linking is explained fully later on in this manual.

Fig 10.1 Mono Mode Grouping

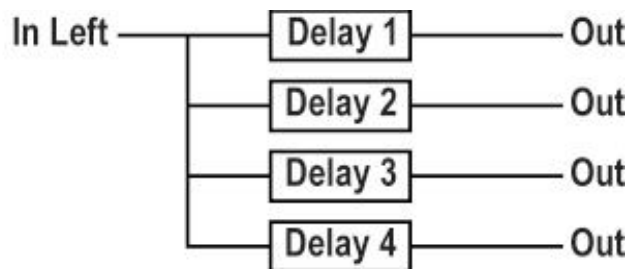
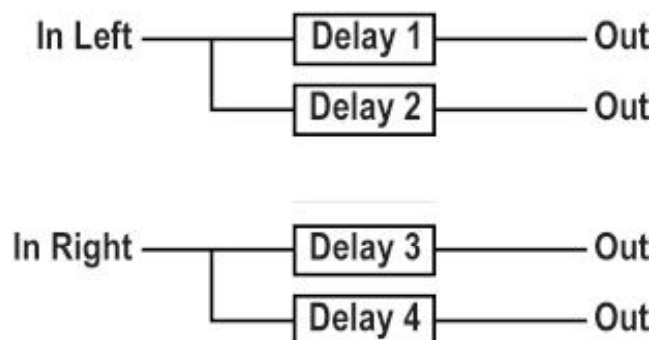

Figure 10.2 Stereo Mode Grouping



Parameter Selection

11.0 Parameter Selection

This section deals with selection of the various modes of operation as well as the adjustment of delay times and signal path gain structure.

Where a feature is common to both the TCS-803 and TCS-804, the selection and adjustment is identical. Where there is a difference, it will be described separately.

We hope you will find it quite intuitive to operate and suggest that you have your unit with you to operate the switches as you read through this section. The key to the diagrams that follow is shown in **Figure 11.1**:

Fig 11.1 Key to diagrams



Press specified button to select function X.



Press and hold specified button to select function X.



Turn the rotary control knob to adjust the parameter.



Push and turn rotary control knob to adjust the parameter.



Indicator light off.



Indicator light on.



Indicator light flashing.



Display reading.

11.1 Bypass The bypass function or IN/OUT provides a switch toggle for cancellation of all delay times. For complete cancellation of all electronic stages and level settings, the output relay option needs to be specified. The bypass is then a complete input/output wired link.



IN: Normal operation.



Out: Total bypass input to output.

11.2 Adjust Delay Time or Distance

The TCS-80X will allow the required delay to be set in 'time' or in 'distance' units. This is selected by operating the units switch. If more delay time is required, an extended memory option is available which is easily installed. To set the delay:



Select a delay to read or adjust it's value.



If required, select to alter display units. Readings in excess of '9999' will show 'FEET' and then automatically change to read feet.



Turn knob for fine adjustment or push and turn for coarse adjustment.

11.3 Adjust Input and Output Level TCS-803

Separate input headroom and output level controls are provided on the front panel to enable optimum operating headroom setting, and individual output level trim.

The input control range allows for a maximum operating level between 0dBu and +20dBu. The output level control allows for individual gain adjustment of the three outputs by plus or minus 10dB. There will be unity gain through the unit when both input and output level controls are in their central position.

It is most important for correct operation of the unit that you set the input level control correctly. As is common for all electronic equipment, care must be taken to ensure that the input signal does not exceed the maximum internal clipping level and the input headroom meter is therefore an important display. When setting up, ensure that on one hand your maximum signal peak does not exceed the 0dB scale point, and on the other that it is not wasteful of dynamic range. It is always adjusted first on initial setting up.

The output level trims will be useful for providing some degree of individual adjustment for each of the three outputs. They can be adjusted following the correct setting of input headroom. Remember that if the input control needs to be turned back, the output control will need to be turned up to restore the through gain as these two controls work together. The input control works to maximise operating dynamic range whilst the output control works to trim the required through gain.

Parameter Selection

11.4 Adjust Input and Output Level
TCS-804

Input headroom and output level adjustment is essential for the correct operation of the unit to maximise dynamic range and trim individual output gains. The section for TCS-803 should be read if more detail is required, but remember that for the TCS-804 all adjustment is performed digitally, rather than with analogue control knobs. To enter the level adjustment mode:

The '|-' symbol in the display denotes tandem adjustment

L denotes left channel adjustment

r denotes right channel adjustment

The display is showing the level in dBu for input clip (0dB on the headroom meter). The symbol to the left is indicating which of the two input channels is selected for adjustment. The '|-' symbol is showing that both channels are being adjusted together.



To Adjust Input Levels



Turn knob to set headroom value in dBu.



Press again to select next channel or step through to exit.

For speed and convenience of use, the sequence that is used to cycle through is different depending on whether MONO, DUAL or STEREO mode has been selected:

MONO: Headroom; out.

TWO CHN: L; r; |-; out.

STEREO LINK: |-; L; r; out.

To Adjust Output Levels



At any time when in the LEVEL mode, a delay button can be selected to allow trimming of output gain. The adjacent LED will stop flashing and remain on, to indicate selection. The display will change to show the input to output through gain, in dB, for the output selected.



Turn the knob to set the gain required in dB

One of the many advantages of this digital level control is seen when adjusting input headroom. The input to output through gain will always be held constant at the dB value previously set because internal circuitry automatically provides the necessary correction to output level. This will be limited to a range such that the sum of input headroom in dB plus the through gain in dB is within a range greater than -10dB and less than +20dB and ensures that the output circuitry can not be set to clip the signal.

WHEN INITIALLY SETTING UP THE UNIT, BE SURE TO SET ALL OUTPUT GAINS TO 0dB. PROCEED TO SET INPUT HEADROOM, AND FINALLY TRIM EACH OUTPUT GAIN TO SUIT. FAILURE TO FOLLOW THIS ROUTINE MIGHT CAUSE THE AUTOMATIC THROUGH GAIN COMPENSATING CIRCUITRY TO RUN OUT OF RANGE.

11.5 Output Mutes

The TCS-804 will also allow independent muting each of the four delay outputs.

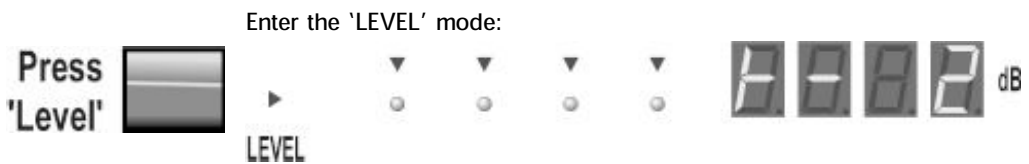

Enter the 'LEVEL' mode:

And select the delay output to mute.



Press in control knob.



Press and turn.



Parameter Selection

The output selected will now be muted. On releasing the control knob and returning to level display, the mute mode will be indicated by "pause" lines to the left hand side of the display.

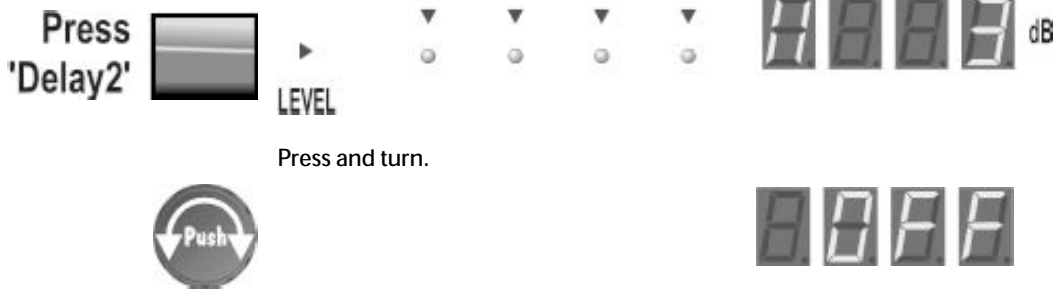

Press and turn.

11.6 Program Store and Recall

There are 12 program memories available for storing different front panel settings. These programs are accessible either from the front panel or via either of the rear panel control interfaces.

For the **TCS-803** each program can store the individual delay times or distance that has been set for the three outputs. Level information is not stored as it is adjusted by the front panel analogue controls.

For the **TCS-804**, both delay time and output gain information are stored, together with information on mode select, stereo linking and relative delay. Input headroom is not stored, as this would be dangerous when recalling programs with widely different settings.

The Program, Store and Recall operations are similar for both units, and to enter the program mode:



The display shows the current program number.



Turn knob to select program number.



Sets parameters to those of displayed program number.



Stores current parameters into displayed program number and will overwrite any previous settings.

Once either Recall or Store has been pressed, the display returns to the delay display that was shown before the Program mode was selected. Press at any time to exit Program mode.



Press at any time to exit Program mode.

For speed and convenience, the PROGRAM mode can be accessed at any time by pressing either the 'store' or 'recall' buttons. The display will change to show a flashing current program number, but the store or recall function will not be activated unless the switch is pressed a second time. Once the button is pressed twice, the current settings are stored or the program is recalled, and the display will return to normal.

When any storable parameter is altered, a '.' appears after the program number to show that the program has been edited and not subsequently stored. It will remain blinking for other display modes as an operator warning. Pressing program STORE will cancel it.



An error message appearing temporarily on the display following a program recall is advising that the program was initially stored in the opposite MONO/DUAL CHN mode than the unit is currently switched to. The program will be recalled, but the error message warns that it may be inappropriate:



11.7 Control Lockout

An 'electronic security cover' is available to stop unauthorised persons from tampering with parameter settings that have previously been entered. The switch to activate this is located behind the front panel and is operated by inserting a small blunt instrument through the round hole adjacent to the IN/OUT switch. The corresponding legend will appear.

'Safe On' allows all parameters to be viewed as normal, but none can be altered.

Press again to return to normal unprotected operation.

The control lockout will not disable any of the rear panel control interfaces. External program selection remains active.

Parameter Selection

11.8 Utility The utility menu is selected by pressing the UNITS button and holding for approximately 2 seconds. Access will then be given to MIDI channel number selection, ambient temperature setting and master/slave transmit mode.

MIDI Channel Select



The display changes to show the current MIDI channel number. Turn the knob to select channel or address number;



Press again to display temperature and again to display master/slave transmit mode.



Press and hold to exit UTILITY.

Temperature Both the TCS-803 and TCS-804 allow compensation for the change in delay times needed to maintain a fixed distance as the ambient temperature varies. In addition, the TCS-804 has as an optional external temperature probe which then makes this correction automatic.

When the probe is not used, the current temperature can be manually entered. If this then changes substantially, a new value entered will cause the delay times to be slowly adjusted to maintain the correct distance.

When using program recall, the delay times which are stored as distance information, will also be correctly adjusted for the current temperature, when recalled.



Turn the knob to set current temperature. If the BSS probe is fitted, it will override the manual setting.



Press and hold to exit to normal display.

The control knob increments in one degree steps and the range of temperature adjustment available extends from -19°C to +44°C. If there are a number of TCS-80X units within an installation, then rather than have a temperature probe fitted to each, it is possible to transfer the temperature data from one master probe to all other units by utilising the MIDI interface. *Please refer to section 12* for an explanation of how to implement this feature.

Please note that when a probe is first plugged in, it can take up to one minute before the temperature appears on the display. Allow at least ten minutes for the probe temperature to stabilise before setting delay times and if the probe is unplugged at any time, the last measured temperature remains active.

The probe should be placed in a position away from equipment heat, out of direct sunlight and where a typical temperature for the venue is likely to be found. A standard screened XLR lead may be used to connect the temperature probe to the jack adapter which plugs into the TCS-804.

Master/Slave Transmit mode When setting up for master/slave operation it is possible to select a number of different modes and these are selected from the utility menu.

Hold 'Units' 

04.16

Press 'Units' 

2000

Press 'Units' 

00.00



Turn the knob to select the required mode from:

tr. -; tr.t°; tr.SL; tr.Pr

Hold 'Units' 

Press and hold to exit to normal display.

Master/Slave Operation

12.0 Master/Slave Operation

By using the MIDI control interface it is possible to interconnect a number of TCS-803 and TCS-804 units so that one unit takes on a MASTER function while other selected ones assume a SLAVE function. In addition there are three different modes of operation to choose from determining what data is to be transferred. Select this from within the UTILITY menu at the same time as setting MIDI channel number. *Refer to section 10.*

Using standard MIDI DIN connecting leads, link the MIDI OUT socket of the unit you wish to be MASTER to the MIDI IN socket of the first SLAVE unit. Continue in a 'daisy chain' fashion linking MIDI THRU to MIDI IN on all the other units that are to be controlled. (The MIDI out socket is only used on the MASTER unit).

Be sure to set equal MIDI CHANNEL numbers for all units, and set the required transmit mode on the MASTER.

When a master unit is first powered up, after a few seconds it will transmit all selected parameters to the slaves. If there is any doubt as to whether the slave units are ready to receive the initial data, check that the slaves are NOT powered up after the master, or that cabling is done after the master is turned on. A second initial dump of data can be sent by altering the transmit mode on the master and then returning it back to that required. Thereafter parameters are only transmitted from the master when they are altered.

Transmit mode 'tr.t°'.
Temperature Linking This mode is for transferring temperature data only, between Master and Slave. It suppresses all data except temperature on the MIDI interface and therefore allows a BSS temperature probe connected into the master to act for all other interconnected units. Where temperature compensation is desirable, this will avoid having to install a BSS probe for each unit in the system.

Transmit mode 'tr.Pr'.
Transmit Program A change in this mode means only program recall and temperature data are transferred. When you Recall a program on the master, all other interconnected units will respond by recalling their own program with the same number. If the display is set to Program number on the slave units, confirmation of program change will be shown.

Temperature data is also transferred so that the stored distance information from the slave units' programs will allow temperature compensated delay times to be shown.

Transmit mode 'tr.SL'.
Transmit Slave This is a full Master/Slave linking mode where all delay settings, in/out status, and temperature data is transmitted by the Master unit for duplication on each slave unit. Program recall and level information is not transmitted and remains locally adjustable.

For this mode you can only mix TCS-803 and TCS-804 units within a system if the latter is set to its mono mode, and similarly all TCS-804 units within the same system must be set to the same mono/dual channel mode. The error message 'Err.5' will be displayed if this is not the case.

Transmit mode 'tr.-'.
Transmit Off Selecting this mode allows MIDI transmit to be switched off, whilst still allowing MIDI receive to be functional. It is of use mainly in large MIDI control setups and controls data to the MIDI OUT socket only.

Linking (804 Only)

13.0 Linking (TCS-804 Only)

13.1 Stereo Pairs

Selecting DUAL CHANNEL mode in a unit gives the possibility to link together the delay times on each left/right group to facilitate maintaining a stable stereo image as the overall delay time offset is adjusted.

Note that Delay 1 and Delay 2 form the first left/right group, whilst Delay 3 and Delay 4 form the second left/right group. The following example uses the first group numbering but it applies equally to the second group.

Set both delay 1 and delay 2 individually to minimum delay, or set an initial imbalance if this is required in your particular situation.

Pressing both switches **SIMULTANEOUSLY** cause them to become linked together:



One of the delay indicator lights will now be flashing to show that this group is linked, and that adjustment of one will drag the other with it.

Turn the knob to set the required delay, and the incremental change will be applied **EQUALLY** to both delay 1 and 2.

Selecting either delay switch will display it's absolute value, which will include any initial offset that was entered prior to being linked.

When the switches are pressed again simultaneously, both units will become **unlinked**.

LINKS may only be switched on or off when in the normal delay mode and **not** when in Relative mode.

Note that LINKING only applies to delay time. The individual through gain for each output remains independent and is adjustable by the LEVEL mode as described earlier.

Linking (804 Only)

13.2 Relative Delay, Mono mode

Relative delay is a display and adjustment mode that allows the assigning of either of the four outputs as a reference such that all other outputs will be linked to it, and dragged when the reference is moved. The relative delay between reference and a chosen other output is also displayed.

This unique facility is invaluable when using the TCS-804 as an array alignment tool, or when using it for loudspeaker driver offset alignment.

Enter the relative mode:



The four flashing red LEDs indicate to choose which delay is to be assigned as the reference. Selecting delay 3 gives:



The red indicator points to delay 3 to confirm it is the reference, the green indicator underneath shows that this is the delay currently being displayed, and the three remaining green indicators are flashing to warn that their respective delay outputs will all be dragged when delay three is adjusted.

Turn the knob to set the required delay, and the incremental change will be applied EQUALLY to delay 1, 2 and 4.



Now select delay 1:



The display will show the RELATIVE delay between delay one and the reference delay (which is delay 3).



Turn the knob to set the required delay RELATIVE to delay 3

It is possible to display and adjust the RELATIVE delay for any of the non reference delay outputs in a similar manner.

Confirmation of the absolute delay time can be obtained by exiting the relative mode and selecting delay display in the usual manner.

Exit relative mode:



and select delay 1:



In the relative display mode both positive and negative delays are indicated to show the true displacement. It is quite likely that you will want to select the units to display and adjust in distance, rather than time, so that the setting up is much more intuitive to what you are measuring.

13.3 Relative Delay, Dual Channel Mode

Relative delay is a display and adjustment mode that allows the assigning of certain outputs as references, such that the other outputs of the pair are linked to it, and dragged with it when it is adjusted. The relative delay between reference and the other chosen output is also displayed.

This unique facility is invaluable when using the TCS-804, and in the dual channel mode there are two possible applications for relative linking depending on whether the system is stereo, or a split band loudspeaker system correcting for array displacement or loudspeaker driver offset.

Enter the relative mode:



Delay 1 red LED confirms that it is the reference for one group, and delay 2 and 3 red LEDs flash to indicate selection of the other reference, depending on the chosen application. For a stereo system select delay 3 as the other reference for the other group:



The two red indicators point to the reference outputs, and the green LED for delay 3 shows that this is the delay currently being displayed. The flashing green LED for delay 4 is indicating that it is linked to delay 3 and will be dragged by it, when adjusted.



Turn the knob to set the required delay, and the incremental change will be applied EQUALLY to delay 3 and 4.

Now select delay 4:



The display will show the RELATIVE delay between delay 4 and the reference delay which is delay 3.

Turn the knob to set the required delay RELATIVE to delay 3.

In a similar manner, the absolute value can be displayed and adjusted for the other reference output, delay 1 and its associated linked output, delay 2.

Confirmation of the absolute delay time can be obtained by exiting the relative mode and selecting delay display in the usual manner.

Linking (804 Only)

Exit relative mode:

Press  'Relative'

.

 mS

and select delay 4:

Press  'Delay4'

.

 mS

If the other reference output has been chosen as delay 2, rather than delay 3, then the above description of operation is still identical but with delay outputs 1 and 2 as reference pulling delays 3 and 4 with them. The indicators will confirm this action.

Stereo links are also active in relative mode and may cause additional delays to be dragged by the reference.

In the relative display mode both positive and negative delays are indicated to show true displacement. It is quite likely that you will want to select the units to display and adjust in distance, rather than time, so that the setting up is much more intuitive to what is being measuring.

Although seemingly complex in description, the relative mode is simple to use after a short time. Remember: The red LED shows the reference delay, and a flashing green LED shows a linked delay which will also be dragged when it's reference is moved.

14.0 Applications

14.1 Time Correction for Audience Distances

In any large public auditorium it is necessary to arrange the loudspeaker system in clusters which are distributed around the arena to help obtain a more uniform distribution of sound level.

For any given position within the arena a listener will be hearing a combination of both the direct sound from the stage, and that from the nearest distributed cluster. Because the speed of sound in air is considerably slower than that of the equivalent electrical signal in the cable, the audible sound from the nearest cluster will be heard by the listener slightly before that arriving from the stage. The time delay between these two needs to be compensated for, otherwise the listener will hear anything from a slightly unintelligible sound to one that is totally indistinct.

Both the **TCS-803** and **TCS-804** can be used to cure this situation by connecting one of its delay outputs to the distributed cluster. The delay time needed will be equivalent to the distance between the loudspeakers. Remember that the speed of sound at 20°C is approximately 343 meters per second. This gives you a rule of thumb of 1 msec/ft, or 3 msec/metre. When using multiple 'delay' clusters or when working in stereo, it will be up to the user to decide whether it is better to use the **TCS-803** or the **TCS-804** switched to mono or dual channel mode.

14.2 Time Correction for Speaker Driver Placement

When a loudspeaker sound system is constructed which utilises different loudspeaker drivers for separate frequency bands it is not generally possible to mechanically mount them all such that each sound source is in the same vertical plane. The effect of this is that phase errors might occur between drivers which produce a substantial cancellation of the signal around the crossover region, and there can also be a general lack of transient clarity to the sound resulting from a poor impulse response due to inaccurate combining of the wavefront arriving at the listener.

It is the vertical displacement of the loudspeakers versus the wavelength of the signal around the crossover region that causes the phase cancellation. Remember that the wavelength of a 1kHz sinewave is 23cm and for a 5kHz signal it is 7cm. For zero cancellation the vertical displacement must be in whole multiples of the wavelength. For a good impulse response the zero phase start point for each loudspeaker drive unit must be in the same vertical plane. Both of these criteria will probably therefore require each MF and HF drive unit to be time delayed from the LF drive unit.

Both the **TCS-803** and the **TCS-804** are ideally suited for this style of correction. However because you need to delay after the main loudspeaker crossover, a separate delay channel is needed for each 'way' of the crossover (*See Figure 14.1*). This can be very wasteful of facilities and not economic for a typical three or four way stereo system.

Applications

A very powerful method utilising delays with a multiple loudspeaker system is to integrate the delay into the crossover such that one multitap delay will provide all the facilities for one channel of a sound system. The BSS FDS-360 Electronic Crossover has built into it a special interface which will allow interconnect of either the TCS-803 or the TCS-804 (See Figure 17.2). For example, two TCS-803 units will then provide all the time correction needed to correctly align a full four way stereo sound system; a single TCS-804 unit will provide all the time correction needed to correctly align a stereo three way system.

A special interface connector is available to assist in the connection of the delay unit to the FDS-360 rear barrier strip (See Figure 14.3).

Fig 14.1 One Delay per Channel

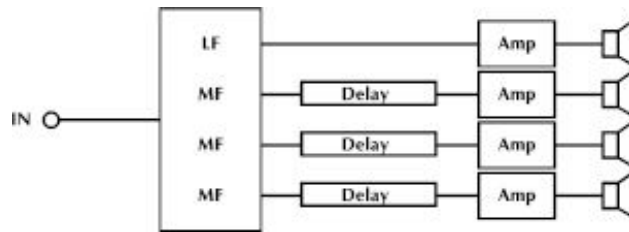

Fig 14.2 FDS-360 and TCS-80X Integration

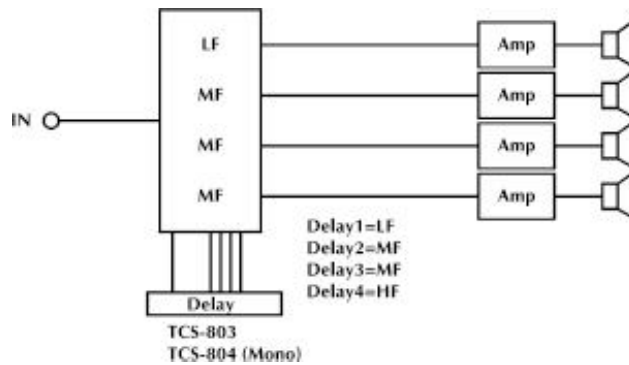
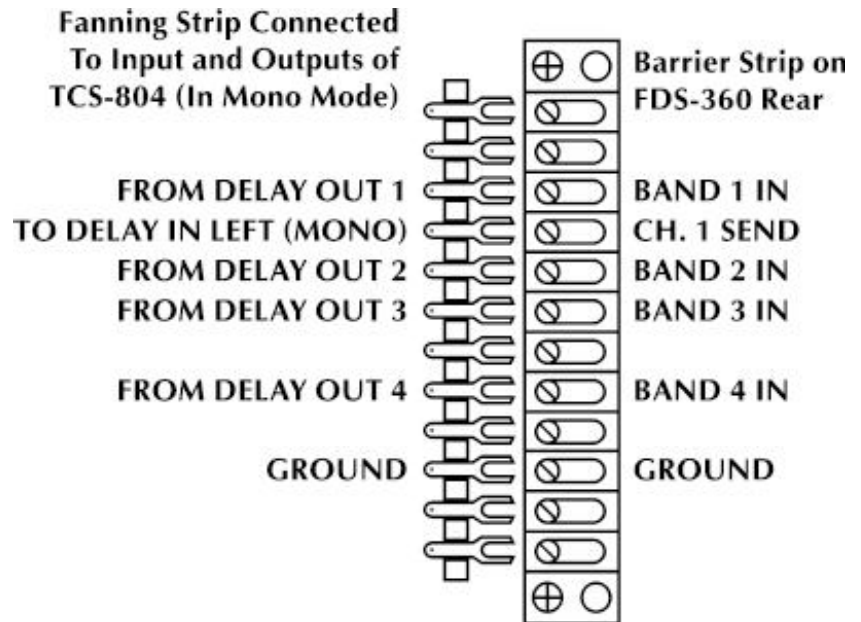

Fig 14.3 FDS-360 to
TCS-80X Wiring



Midi Implementation

15.0 Midi Implementation

Both the TCS-803 and the TCS-804 can be controlled externally via the MIDI control interface. All the relevant parameters are accessible where applicable. However, both input headroom and output gain are not available for the TCS-803 model.

FUNCTION	OUT	IN	REMARKS
CHANNEL Default Changed	1-16 1-16	1-16 1-16	Memorised
MODE	X	X	
NOTE NUMBER	X	X	
VELOCITY	X	X	
TOUCH	X	X	
PITCH BENDER	X	X	
CONTROL CHANGE			
Delay 1 MSB 17	O	O	160us steps up to 2.6s
LSB 49			
Delay 2 MSB 19	O	O	
LSB 51			
Delay 3 MSB 18	O	O	0-31 x10us steps INC 32-63 x2.56ms steps INC 64-95 x10us steps DEC 96-127 x2.56ms steps DEC
LSB 50			
Delay 4 MSB 16	O	O	
LSB 48			
D1 Increment 71	O	O	Gain (n-6)dB Range ±6dB
D2 Increment 73	O	O	
D3 Increment 72	O	O	
D4 Increment 70	O	O	
Level 1 81	X	O	Clip Level (20-n)dBu Range -9dBu to +20dBu Mute 1=1, Mute 2=2, Mute 3=4 Mute 4=8. Add to combine.
Level 2 83	X	O	
Level 3 82	X	O	
Level 4 80	X	O	
Headroom L 75	X	O	Temp (n-19)°C -19 to +44°C Program (n+1) Prog 1 to 12
Headroom R 76	X	O	
Mute 77	X	O	
Temperature 78	O	O	
Store PGM 79	X	O	Switches (see notes)
Bypass 84	O	O	
Stereo Mode 85	O	O	
PROGRAM CHANGE	0-11	0-11	
True number	1-12	1-12	
SYSTEM EXCLUSIVE	X	X	
SYSTEM COMMON	X	X	
SYSTEM REAL TIME	X	X	
AUX	X	X	

NOTES X=No O=Yes

Midi Implementation Chassis/0v Link Removal

Receive Notes:

The Delay LSB must precede the MSB. If Delay LSB is not received then it is assumed to be 0. Increment may be used to obtain resolution down to 10us.

The Stereo mode flag checks for the correct setting of the mono/stereo switch and produces an error message if there is a conflict.

Transmit Notes:

Delay times are transmitted as LSB then MSB then INCRement.

General Notes:

Delay times are transmitted and received correctly for 20°C. If the temperature value set on the unit is different to this, then values will automatically be adjusted.

16.0 Chassis/0v Link Removal

For both TCS-80X units the signal 0v ground is connected to the metal chassis, which in turn is connected to the safety ground. In the unlikely event that the link needs to be removed, or if a small amount of impedance needs to be added to reduce earth loop currents, then proceed as follows:

Since both the audio inputs and outputs are wired fully balanced, we suggest that you fully check that all audio wiring is correct prior to proceeding.

CAUTION: Under NO CIRCUMSTANCES should the incoming ground wire be disconnected from the power line cord or from the internal chassis connection as an alternative to this procedure.

- Disconnect the mains power cord and remove the top cover from the unit.
- Locate the green wire bolted to the chassis immediately above the 9-pin 'D' connector which terminates onto the PCB at a point marked 'AGND' (*See Figure 16.1*).
- Remove the end of this wire link from the chassis connection, fold over and FULLY INSULATE.
- The signal 0v (AGND) is now separate from the chassis.

The other green wire terminated onto this chassis bolt connects the output XLR pin 1 connections to the chassis. Under NO CIRCUMSTANCES is it recommended that this link is removed.

BSS Temperature Probe

17.0 BSS Temperature Probe

TCS-804: To enable the temperature corrected delay time feature of the **TCS-80X** series to be automatically implemented, there is an external temperature measuring probe available as an additional option.

It is supplied mounted into an standard 3 pin XLR connector and comes complete with an XLR to RTS jack convertor. The probe plugs into the RTS jack socket on the **TCS-804** rear panel. Should you wish to mount the probe some distance away from the unit, use a standard 3 pin balanced XLR cable as an extension.

Remember that control of a number of **TCS-80X** units from the one temperature probe can be done via the MIDI control interface.

Transient Suppressor Replacement Extended Memory

18.0 Transient Suppressor Replacement

The primary of the mains transformer within the TCS-80X is protected against high voltage spike interference by two voltage dependent resistors. These provide a short circuit to voltage peaks in excess of their maximum rating.

Should the TCS-80X be inadvertently connected to 3 phase line/line voltages, or to 240V when selected to 120V, or any other incorrect voltage, these suppressors are likely to fail in a protective short circuit mode. This will be demonstrated by repeated mains fuse failure when powering up the unit.

Even in this case of extreme overvoltage, the TCS-80X are protected against failure, and the simple removal of these suppressors will allow the unit to be used again. However, it is important that they are replaced as soon as possible to ensure continued protection.

Figure 18.1 indicates the location and specification for the suppressors.

Fig 18.1 Suppressor location

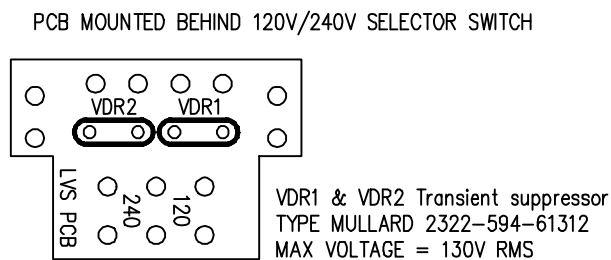

19.0 Extended Memory

The maximum available delay time can be easily extended should this be required.

Refer to the spare parts information sheet at the back of this manual for details on part numbers for the relevant parts. You will require 2 off for the TCS-804 and 1 off for the TCS-803.

Please remember that these chips are static sensitive and that they should be handled with care. If you are not familiar with the correct handling procedures then we suggest you refer the installation to your local BSS dealer.

REMEMBER TO MOVE THE INTERNAL JUMPER CN10A/B, LOCATED NEAR THE EPROM.

TCS-803: FIT IC42 ONLY

TCS-804: FIT IC42 and IC43.

Fig 19.1 Extended Memory Jumper Setting

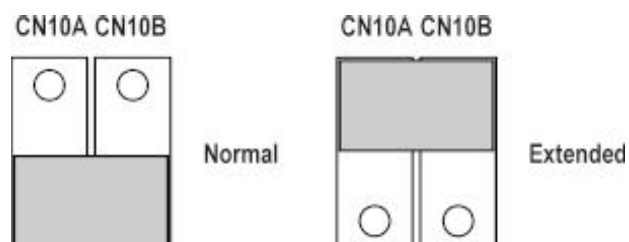

Option Transformers

20.0 Option Transformers

Provision is made internally for transformers to be fitted to the electronically balanced inputs if required. Refer to the spare parts information sheet at the rear of this manual for details on required parts. You will need one transformer for each channel. The transformers are easily fitted onto the main PCB in the positions shown (*See figure 20.1*). The orientation must be such that the white 'spot' on the transformer corresponds with the ring printed on the circuit board.

Wire links LK101, LK102, LK201 and LK202 must also be cut.

Fig 20.1 Transformer
Option Location

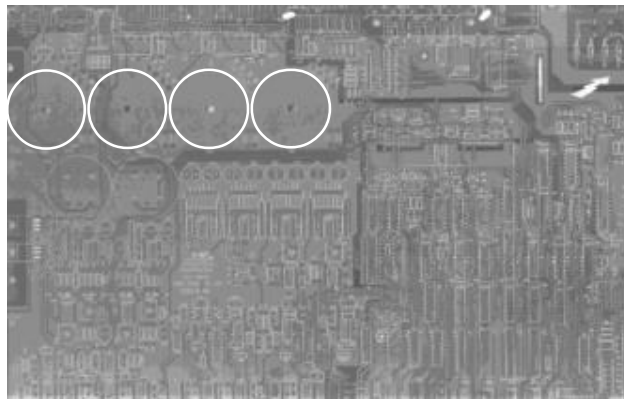

Specifications

21.0 Specifications

Input section: 10k ohm electronically balanced, +2-dBu maximum input level via XLR 3-31 or equivalent.

Output section: Electronically balanced and floating, capable of driving +20dBu into 600ohms or greater via XLR 3-32 or equivalent.

System Performance

Conversion method: Dynamic floating window PCM.

Frequency Response: ± 0.5 dB, 20Hz to 20kHz.

Dynamic Range: Typically 105dB, no pre-emphasis.

Distortion: $\leq 0.03\%$ 20Hz - 20kHz at +10dBu level.

Group Delay Dev: $\pm 7\mu$ S from 20Hz to 20kHz.

Stereo Sync: $\pm 0.5\mu$ S.

User Memory Type: EEPROM. No batteries are required.

Parameters

Delay Range - Stereo: 75 μ S - 650mS. (1.3 seconds Optional).

Mono: 75 μ S - 1.3S. (2.6 seconds Optional).

Minimum Step Size: 10 μ S (3.4mm at 21°C)

Input Level

TCS-804: +10dBu, ± 10 dB adjustable by level control.

TCS-803: -9 to +20dBu, digitally adjustable in 1dB steps.

Output Level

TCS-803: ± 10 dB adjustable by level control.

TCS-804: ± 6 dB digitally adjustable in 1dB steps.

Temperature: -19°C to +44°C manual entry or automatic with probe.

Parameters

Remote pgm Select: 9 Pin submin D connector, 3 x 4 contact closure matrix for selection of 12 programs.

MIDI: IN, THRU, OUT 5 Pin 180° DIN connector.

Temperature Probe: 0.25" RTS jack socket for BSS probe.

Specifications

Display

Input Headroom: 7 step linear showing 0dB to +20dB.

Parameters: 4 digit plus unit/status LEDs.

Power

AC 50VA, 50-60Hz, 120v/240v selectable externally. Pluggable IED power cord.

Dimensions/Weight

Dimensions: 482 x 44 x 228mm
19 x 1.75 x 9".

Weight: 4.5kg net.

Options

Transformer Balancing: Internal.

Memory Expansion: TCS-803 to 1.3 seconds.
TCS-804 MONO to 2.6 seconds.
TCS-804 DUAL CHN to 1.3 seconds per channel.

Temperature Probe: Allows automatic temperature compensation for delay time. Accurate to $\pm 3^{\circ}\text{C}$.

Security Cover: Mechanical fixing to supplement electronic lockout.

Warranty Information

22.0 Warranty Information

This unit is warranted by BSS Audio to the original end user purchaser against defects in workmanship and the materials used in its manufacture for a period of one year from the date of shipment to the end user.

Faults arising from misuse, unauthorised modifications or accidents are not covered under this warranty. No other warranty is expressed or implied.

If the unit is faulty it should be sent, in its original packaging, to the supplier or your local authorised BSS Audio dealer with shipping prepaid.

You should include a statement listing the faults found. The unit's serial number must be quoted in all correspondence relating to a claim.

IMPORTANT

We recommend that you record your purchase information here for future reference.

Dealer Name: _____

Dealer Address: _____

Post/Zip Code: _____

Dealer Phone No.: _____

Dealer Contact Name: _____

Invoice/Receipt No.: _____

Date of Purchase: _____

Unit Serial Number: _____

In keeping with our policy of continued improvement, BSS Audio reserves the right to alter specifications without prior notice.

The TCS-80X was designed and developed by BSS Audio, Hertfordshire, England.

Phone (+44) (0)1707 660667. Fax (+44) (0)1707 660755.

World Wide Web address: <http://www.bss.co.uk>

Index

Index

A		Transmit Program	26
Applications		Transmit Slave	26
Audience Distances	31	Memory	
Speaker Driver Placement	31	Extended	37
B		MIDI	34
Bypass	19	Mode Setting (804)	17
C		O	
Chassis/0v Link Removal	35	Output Level	
Connections		803	19
Control	15	804	20
Input	14	Output Mutes	21
Output	15	P	
D		Parameter Selection	18
Delay Time	19	Power Connection	13
Display	16	Power Fusing	13
Errors	17	Powering Up	16
Distance	19	Program	
E		Recall	22
Earthing Requirements	7	Store	22
F		R	
Front Panel		Rear Panel	
803	8	803	8
804	10	804	10
I		S	
Input Level		Settings	
803	19	Factory Default	16
804	20	Specifications	39
Installation	12	T	
L		Temperature Probe	36
Linking (804)		Transformers (Optional)	38
Relative Delay, Dual Channel	29	Transient Suppressor	37
Relative Delay, Mono	28	U	
Stereo Pairs	27	Unit dimensions	12
Lockout	23	Unpacking	7
M		Utility Menu	
Master/Slave Operation	26	Master/Slave Transmit	25
Temperature Linking	26	MIDI Channel Select	24
Transmit Off	26	Temperature	24
N		W	
O		Warranty Info.	41
P		Wiring convention	14

User Notes

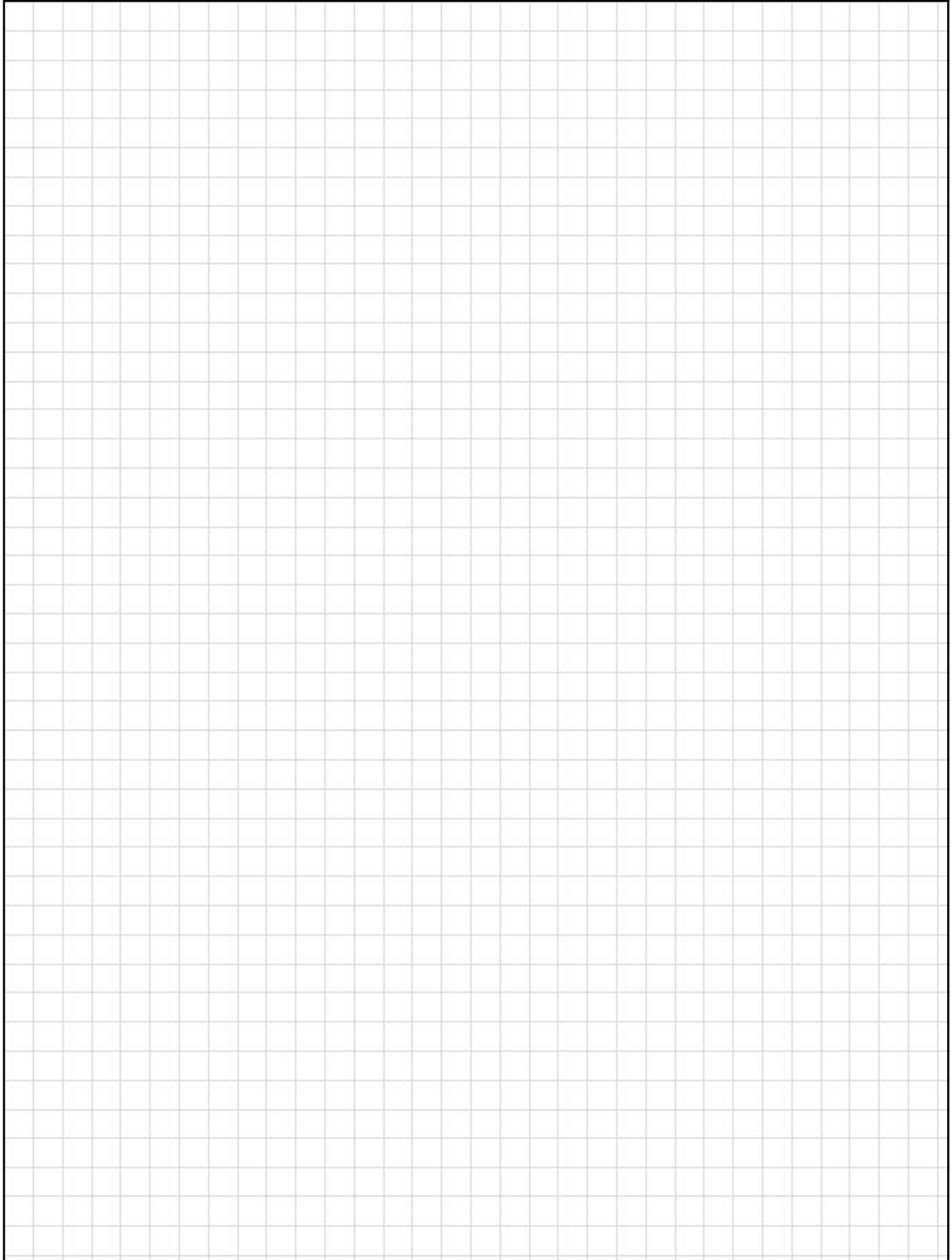

User Notes

A large rectangular area filled with a fine grid pattern, intended for users to take notes or record data. The grid consists of small, uniform squares covering the majority of the page's content area.

User Notes

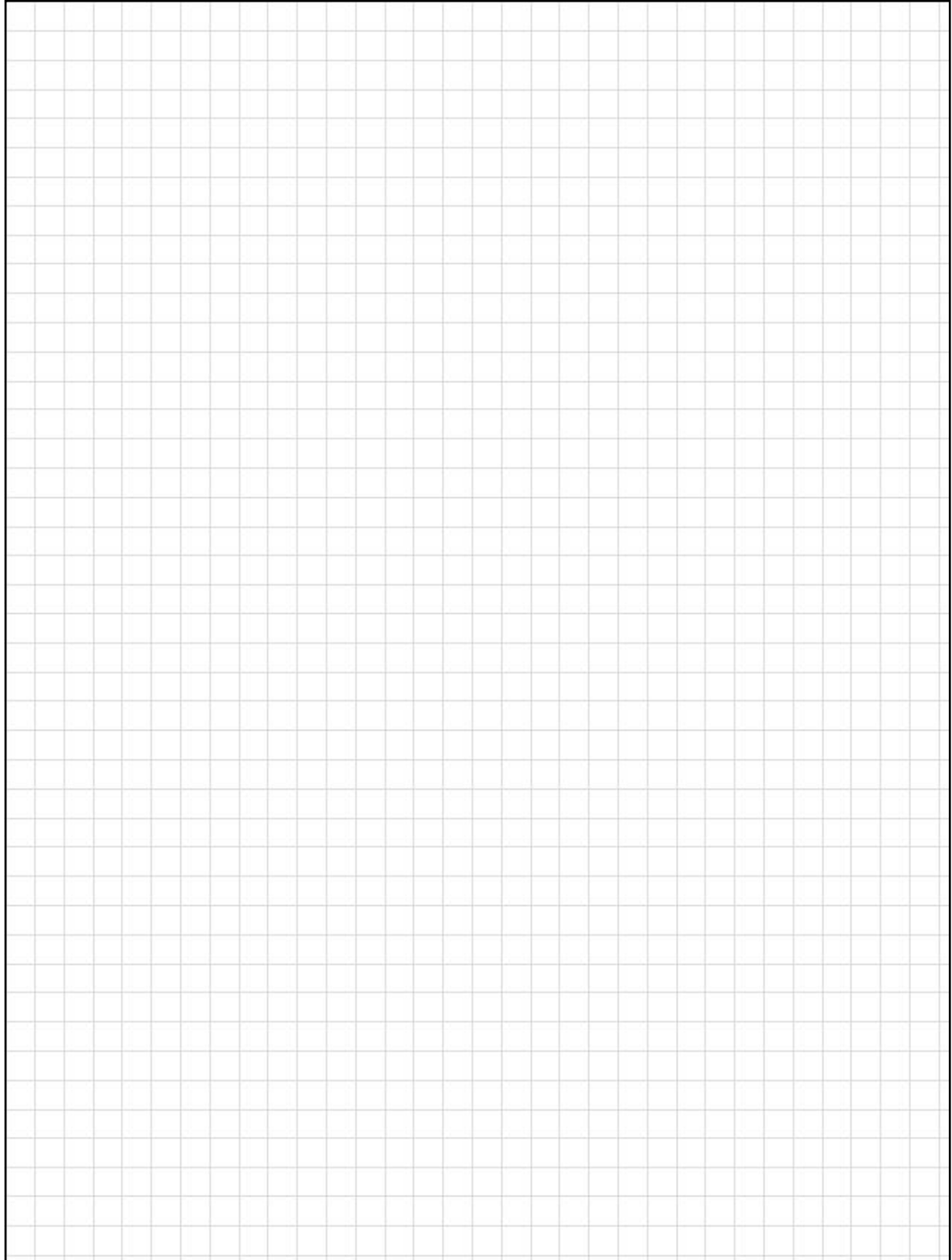

User Notes

A large rectangular area filled with a fine grid of small squares, intended for handwritten notes or calculations. The grid covers most of the page's vertical space below the header and above the footer.